

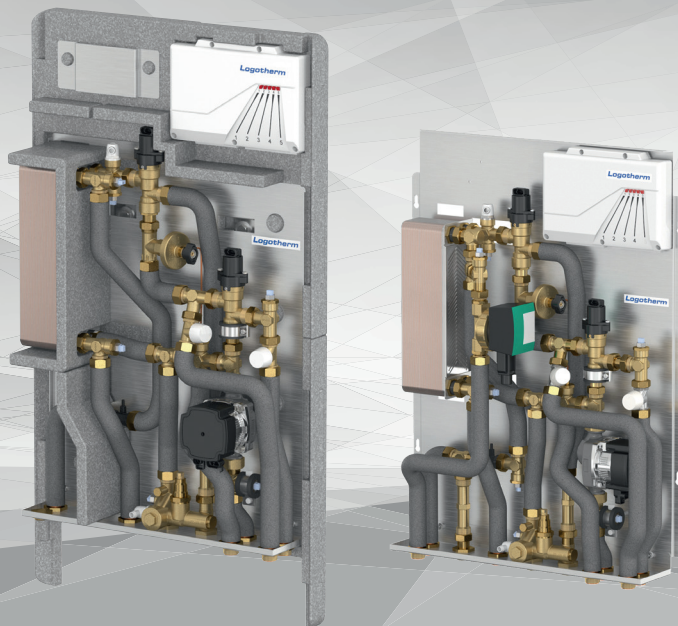

# LogoMatic G2

UC / MC/ MC-UC, electronically controlled, app-controlled  
S-/M-/L-line as complete or ready-to-use stations



**ENG** Installation and operating instructions



<b>Acronyms</b>	
CW	Domestic water cold
HW	Domestic water hot
FL	Heating flow line
RL	Heating return line
MC	Mixed circuit
UC	Unmixed circuit
DWC	Domestic water circulation
L	Length
HC	Heating circuit
MT	Male thread
HE	High-efficiency
BFD	ball valve for filling and draining
prim.	Primary circuit
sec.	Secondary circuit
WF	Width across flats
DWH	Domestic water heater
Htg.	Heating
BP	Backflow preventer
Chap.	Chapter
STM	Safety temperature monitor
ETS	External temperature sensor
UFH	Underfloor Heating
CS	Complete stations

## Table of contents

<b>1. Safety instructions</b>	<b>4</b>
1.1 Intended use	5
1.1.1 Use for intended purpose	5
1.1.2 Improper use	6
1.2 Device designation	6
1.3 Information on hazards	7
1.4 What to do in the event of breakdown or leaks	8
1.5 Spare and wear parts	8
1.6 Requirements on trained engineers	8
1.7 Liability	8
<b>2. Functional description</b>	<b>9</b>
<b>3. LogoMatic G2 - electronically controlled heating interface station</b>	<b>10</b>
3.1 Article numbers for prefabricated stations	10
3.2 Technical data	12
3.3 Design and components	13
3.4 Installation	15
3.4.1 Insulated surface-mounted variants with multi-part thermal insulation	17
<b>4. Individual station components (depending on variant)</b>	<b>20</b>
4.1 Optional heat meter installation	20
4.2 Optional domestic cold water meter installation	21
4.3 Zone valve for heating circuit	22
4.3.1 Optional safety temperature limitation and actuator	23
4.4 Dirt trap and thermostatic circulation bridge	24
4.5 Differential pressure regulator	25
4.7 Mixed heating circuit (depending on variant)	27
4.7.1 High-efficiency heating circuit pump	28
4.8 Hot water throttle	29
4.9 Domestic water circulation with pump and BP	30
4.10 Optional accessories	32
4.10.1 Heating circuit manifolds	33
4.10.2 Terminal strip for underfloor heating circuit manifolds	34
4.10.3 Static heating circuit (with MC-UC variants) and simultaneous heating circuit distribution	35
4.10.4 Ball valve sets, DN 20 straight (BV)	36
4.10.5 Mounting rails with ball valves (FFR)	36
4.10.6 Cover hoods and cladding housing	37
4.10.7 Sample configurations (or complete stations CS)	39
<b>5. Commissioning</b>	<b>42</b>
5.1 Flushing and filling	42
5.2 Initial start-up	42
<b>6. Maintenance and service</b>	<b>43</b>
<b>7. Pressure loss characteristic curves</b>	<b>44</b>
<b>8. Troubleshooting</b>	<b>46</b>
<b>9. Spare parts</b>	<b>47</b>

## 1. Safety instructions



Please follow these safety instructions carefully to prevent hazards and injury to persons and property.

These operating instructions are primarily designed for the safe use and installation of the device and make no claims to completeness.



These operating instructions describe the functionality of the device and are intended to provide information about the required safety instructions and to draw attention to possible hazards. If you should become aware when reading them of any inaccuracies or points requiring clarification, please contact the manufacturer. Further technical information can be found in the other applicable documents and must also be observed.

These operating instructions are valid only for the described device and are not subject to the manufacturer's revision service. The sketches and drawings they contain are not to scale.

- Keep the operating instructions within easy reach of all employees instructed to carry out work on the device so that they can refer to them as required.
- Keep the operating instructions in a clean, complete and legible condition throughout the entire period of use.
- Read the operating instructions before working on the device for the first time and consult them whenever uncertainties or doubts arise as to how the device should be handled.
- Should you come across any discrepancies when reading these operating instructions or should anything remain unclear, please contact the manufacturer.

### Target group

These instructions are intended exclusively for authorised trained experts.

Only trained experts or installers authorised by the respective competent utility companies are permitted to work on heating systems and domestic water, gas and electric circuits.

### Regulations

When carrying out work, you must comply with:

- The statutory accident prevention regulations,
- The statutory environmental protection regulations,
- The German Employer's Liability Insurance Association regulations,
- The pertinent safety requirements of DIN, EN, DVGW, TRGI, TRF and VDE,
- ÖNORM, EN, ÖVGW-TR Gas, ÖVGW-TRF and ÖVE,
- SEV, SUVA, SVGW, SVTI, SWKI and VKF
- and all new and regionally applicable regulations and standards

## Instructions for working on the system and system parameters

- Disconnect the system from the mains and monitor it to ensure that no voltage is being supplied (e.g. at the separate cut-out or a main switch).
- Secure the system against being restarted.
- **WARNING: Risk of scalding:** If media temperature > 60 °C
- Heating system parameters:
 

Permissible nominal pressure rating:	PN10
Max. permissible operating temperature:	100 °C
- Sanitary system parameters:
 

Permissible nominal pressure rating:	PN10
Min. CW pressure	1 bar
Max. permissible operating temperature:	100 °C
Optimum operating pressure:	2 bar
- The devices must be installed in enclosed, frost-free spaces.
- Any noise emissions or radiant heat from the station must be taken into account in the choice of installation site.
- Observe the safety areas in accordance with EN 60529 when designing and installing the system
- Any sanitary installation must be made safe in compliance with DIN 1988 or DIN EN 806, i.e. with the use of a safety valve and, where applicable, an expansion vessel.

### Note:

In the case of anticipated high primary temperatures of >60 °C, thermostatic scalding protection must be ensured at the domestic hot water draw-off point in order to restrict the outlet temperature (in the event of a power failure).

The potential equalisation or protective earthing is achieved via the controller and the 230 V power supply.

## 1.1 Intended use

### 1.1.1 Use for intended purpose

Heat interface stations are used to transfer heat between the supply network and the heat consumer. Heat interface stations may only be used for this purpose in compliance with the maintenance and operating instructions and all relevant standards and regulations.

All instructions in the operating instructions must be followed and the maintenance plan adhered to.

**Any deviation from the intended use may cause hazards and is not permitted.**

The LogoMatic heat interface station provides a residential station with space heating and domestic hot water according to the continuous flow principle. Any additional or alternative use is impermissible and regarded as an unintended use.

Appropriate use in heating and domestic water systems in accordance with the applicable DIN standards. Installing and operating the assembly incorrectly will invalidate any warranty claims. The shut-off valves may only be closed by an approved specialist when servicing, otherwise the safety valves will not work.

The LogoMatic heat interface station is not suitable for installation in adjacent recreation rooms or bedrooms.

An avoidance of sound transmission in and to adjacent walls or rooms must be observed!



**Caution:**

Do not make any changes to the electrical components, the design of the system or the hydraulic components! This would adversely impact on the safe function of the system.

**Instructions concerning the place of use:**

Before our products are used, they must be checked for suitability for the planned application in question.

In particular for heating systems, please take into account the properties of the heating water in accordance with VDI 2035 to protect the heating system and, for domestic water applications, the water quality at the place of use.

In the case of critical water qualities, please take suitable measures where necessary (e.g. water treatment) to prevent functional impairment and/or damage, e.g. corrosion damage. In particular, please check the permissible limit values, e.g. electrical conductivity, the pH value, the German hardness level and the ammonium concentration.

Furthermore, in Germany all applicable norms, regulations and guidelines specific to the federal states must be taken into consideration, alongside the instructions in the applicable installation and operating manuals.

Further information can be found in the download section of [www.flamcogroup.com](http://www.flamcogroup.com).

### 1.1.2 Improper use

Using the device in any way that does not correspond to the intended use may cause hazards and is not permissible.

**In particular, the following are not allowed:**

- The throughflow of liquids other than water with the described properties
- Use of the device without prior knowledge of the operating instructions
- Use of the device without legible warning and information signs Use of the device in a defective condition

## 1.2 Device designation

Designation:	LogoMatic G2
Function:	Transfer of thermal energy to the heating supply and hot water preparation
Type:	Prefabricated/complete stations as S-/M-/L-Line in different versions (UC, MC, MC-UC)
Manufacturer:	Meibes System-Technik GmbH

### 1.3 Information on hazards

The safety and warning information draws attention to residual hazards that cannot be avoided due to the design and construction of the device. Please always observe the measures shown for avoiding these hazards.

Never alter or modify the station by yourself. Such work may only be carried out by **qualified specialist personnel**. This also applies to the electrical installation.



When the system is in operation, water-carrying components will be hot. Touching these system components can lead to scalding. The interface station and its heat-carrying components are mostly equipped with permanent insulation. This insulation not only prevents unnecessary thermal losses but also protects against accidental contact and burns. The insulation must therefore only be removed for maintenance or repair purposes and replaced correctly on completion of such work.

**Warning:** For some components and station variants, no insulation is fitted at the factory. You must therefore take extra care to avoid accidental contact.

The system is operated using hot, high-pressure water, which can cause scalding on contact. You should therefore open the bleed or drain valves carefully and not work on pressurised parts.



The control components (controller, pumps, etc.) are powered by mains voltage. **Therefore, always ensure the station is disconnected from the mains supply when carrying out any maintenance or repair work. Secure the system against unauthorised operation.**

Life-threatening electric shocks can be caused by spray or splashing water. Escaping water can also render the safety devices inactive.

Any changes made to the station that have not been authorised by the manufacturer will invalidate any warranty claims.

#### Residual hazards:

The equipment has been built according to the state of the art and in accordance with recognised safety regulations. The following residual hazards may arise during installation, commissioning, maintenance and disassembly:

#### Warning: Risk of scalding from high media temperature

- Work particularly carefully.
- Use safety clothing (e.g. heat-resistant protective gloves).
- If necessary, surfaces must be thermally cleared before commencing work.
- Use stipulated tools.

#### Hazard: Risk of injury from electrical voltage

- Only instructed, qualified electricians are permitted to work on electrical equipment.
- Electrical installation spaces must always be kept locked.

#### **1.4 What to do in the event of breakdown or leaks**

- Close media lines using the appropriate valve.
- Contact a suitably trained expert or customer service of the manufacturer.

The device will only be cleared for operation again when the trained engineer has remedied the fault and restored the device to its intended condition.

#### **1.5 Spare and wear parts**

All spare and wear parts used must correspond to the technical requirements defined by Meibes System-Technik GmbH. This is guaranteed only with genuine spare parts. The manufacturer is not liable for damage caused by the use of unapproved spare and wear parts or ancillary materials. Appropriate spare and wear parts can be found in the other applicable documents.

#### **1.6 Requirements on trained engineers**

A trained expert must have undergone advanced technical training and have sufficient experience to independently perform complicated tasks or work associated with residual hazards. Such experience will in each instance refer to a specialism, e.g. maintenance, working on electrical systems, systems mechanic for sanitary, heating and air conditioning technology. In preparation for impending work, a trained expert must be able to correctly estimate the feasibility, risks and hazards as well as the equipment required. A trained expert is expected to be able to understand complex and minimally detailed plans and descriptions and to use appropriate means to obtain any missing and essential detailed information. The trained expert must be able to restore and check the intended condition of a system. A worker can be a trained expert in several fields.

For work on the electrical equipment, only trained electricians according to DGUV regulation 3 may be used.

#### **1.7 Liability**

We reserve all copyrights to this document. Misuse thereof, in particular reproduction or disclosure to third parties, is prohibited. These installation and operating instructions must be given to the customer. The technician carrying out and/or authorising the work (e.g. installer) must explain the functioning and operation of the system to the customer in a readily comprehensible way.



## 2. Functional description

The electronically controlled LogoMatic G2 heat interface stations provide a residential station with domestic hot water and heating. The domestic water is heated via a stainless-steel plate heat exchanger and electronic control valves based on the continuous flow principle. The station must simply be connected to the flow and return lines and the cold water line. The integrated controller is operated at 230 V / 50 Hz. The mains fuse is 10 A.

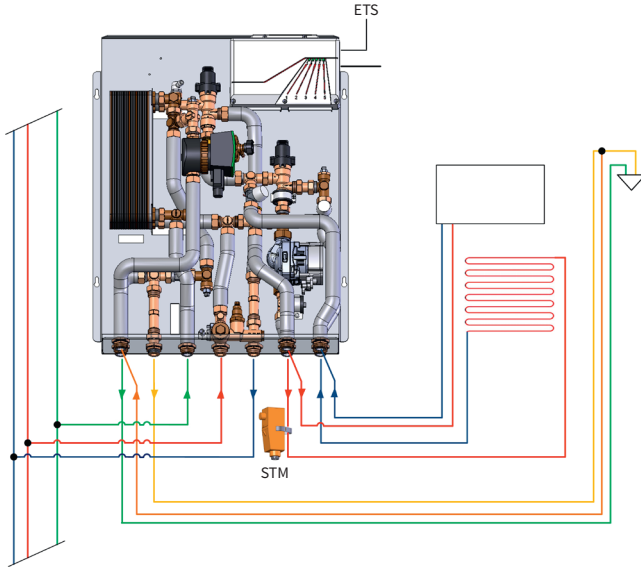

Fig.: Example integration of a LogoMatic G2 MC-UC-DHWC station with mixed HC and optional STM and ETS

Note concerning LM G2 Weather-driven heating circuit control via optional external temperature sensor (ETS). STM with electrothermal actuator can be ordered as an optional extra. (see chap. 4.3.1)

A differential pressure regulator in the station allows for hydraulic balancing of the heating circuits. The zone valve integrated in each device also permits adjustment of the dwelling heating circuit. Installing a living space or reference room controller (option) allows the independent operation of the dwelling heating circuit.

Adaptors for water meter and heat flow meter (L = 110 mm, 2 x 3/4" MT) are included in the scope of supply of each station.

Note: Additional accessories or options can be found in the current price list (ETS, STM etc.)

### Description of the hot water preparation process:

Heating takes place at a preset control value (50 °C; with circulation 60 °C). The control value can be adjusted as required by the factory customer service team.

If the flow meter identifies a draw-off, the hot water preparation is adjusted to the preset setpoint value via the control valves.

### 3. LogoMatic G2 - electronically controlled heating interface station

#### 3.1 Article numbers for prefabricated stations

Art. no. keys for Logomatic G2 prefabricated stations

Example: Art. no.	Identification number		Model	Unit characteristic/ abbreviation		
M11114.XYZ	Heating type	X=	4	UC	for an unmixed HC	
			5	MC	for a mixed HC	
			6	MC-UC	for one mixed and one unmixed HC	
	Performance classes	Y=	_ / 0	S-Line	as steel version for FM/SM	F/S
			1	M-Line		
			2	L-Line		
			3	S-Line	as insulated version for SM	SI
			4	M-Line		
			5	L-Line		
	Domestic water circulation	Z=	-	without DWC	with copper-soldered PHE	CU
			1	with <b>DWC</b> (DHW-C)		
			2	without DWC	with <b>sealed</b> copper-soldered PHE	SX
			3	with <b>DWC</b> (DHW-C)		

Note: Suitable complementary products are available as optional extras for prefabricated stations. In contrast to complete stations (CS), where e.g. ball valves, manifold for floor heating circuits or hoods are included (see chap. 4.10.7).

#### Prefabricated stations with copper-soldered PHE (without DWC)

Steel versions for SM or FM and insulated. Surface-mounted* versions	S-Line	M-Line	L-Line
<b>LogoMatic G2 variants</b>	12 L/min (35 kW)	17 L/min (46 kW)	22 l/min (60kW)
UC	M11114.4 /-43	M11114.41 /-44	M11114.42 /-45
MC	M11114.5 /-53	M11114.51 /-54	M11114.52 /-55
MC-UC	M11114.6 /-63	M11114.61 /-64	M11114.62 /-65

### Prefabricated stations with copper-soldered PHE and DWC

Flush/ and surface-mounted* versions	S-Line	M-Line	L-Line
LogoMatic G2 variants	12 L/min (35 kW)	17 L/min (46 kW)	22 l/min (60kW)
UC	M11114.401 /-431	M11114.411 /-441	M11114.421 /-451
MC	M11114.501 /-531	M11114.511 /-541	M11114.521 /-551
MC-UC	M11114.601 /-631	M11114.611 /-641	M11114.621 /-651

### Prefabricated stations with sealed PHE (without DWC)

Flush/ and surface-mounted* versions	S-Line	M-Line	L-Line
LogoMatic G2 variants	12 L/min (35 kW)	17 L/min (46 kW)	22 l/min (60kW)
UC	M11114.402 /-432	M11114.412 /-442	M11114.422 /-452
MC	M11114.502 /-532	M11114.512 /-542	M11114.522 /-552
MC-UC	M11114.602 /-632	M11114.612 /-642	M11114.622 /-652

### Prefabricated stations with sealed PHE and DWC

Flush/ and surface-mounted* versions	S-Line	M-Line	L-Line
LogoMatic G2 variants	12 L/min (35 kW)	17 L/min (46 kW)	22 l/min (60kW)
UC	M11114.403 /-433	M11114.413 /-443	M11114.423 /-453
MC	M11114.503 /-533	M11114.513 /-543	M11114.523 /-553
MC-UC	M11114.603 /-633	M11114.613 /-643	M11114.623 /-653

\* Any type of enclosures (steel or also insulating enclosures) for prefabric stations must be ordered separately. They are not included in the named article numbers.

### 3.2 Technical data

<b>Dimensions:</b>	Height x Width x Depth (H x W x D in mm)
Prefabricated station without hood SM/ FM variant	576 x 775 x 110 (depending on design)
Insulated SM variant	approx. 556 x 990 x 163
<b>Bottom connections</b>	3/4"
<b>Heating output</b>	10 kW (20 K)
<b>Hot water output</b>	35; 46 or 60 kW (in the case of domestic water heating from 10 to 50 °C und primary nominal FL temp.), draw-off volume 12; 17 or 22 l/min
<b>Nominal flow line temp. (primary)</b>	65 °C

#### Application limits:

<b>Max. flow line temp. (primary)</b>	100 °C
<b>Permissible nominal pressure rating (primary):</b>	PN10
<b>Max. differential pressure(primary):</b>	2.5 bar
<b>Min. differential pressure(primary):</b>	0.03 bar
<b>The factory setting of the differential pressure regulator:</b>	10 kPa
<b>Max. temp. (sanitary)</b>	100 °C
<b>Permissible nominal pressure rating (sanitary):</b>	PN10
<b>Min. operating pressure (sanitary):</b>	1 bar

### 3.3 Design and components

example representations:

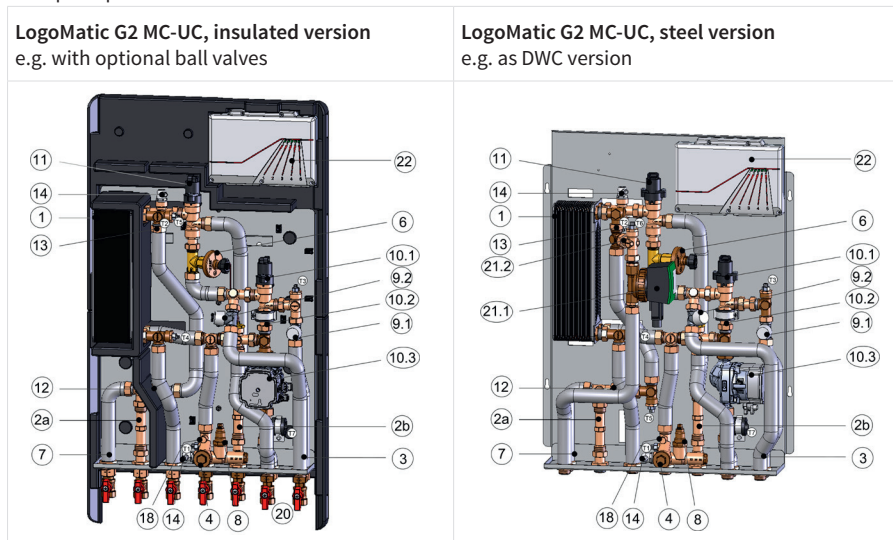

#### Legend

No.	Components	Comment
1	Plate heat exchanger, stainless steel, copper soldered/copper soldered and sealed	24 / 40 / 60 plates
2a	Adaptor for the cold water meter	(L = 110 mm, 2 x 3/4" MT)
2b	Adaptor for the heat meter	(L = 110 mm, 2 x 3/4" MT)
3	Insulated stainless steel corrugated pipe	
4	Dirt trap, sealed with plug	
6	Differential pressure regulator DN15 (5-25 kPa) Kvs=1.6	
7	Cold water connection to dwelling	
8	Thermostatic circulation bridge, adjustable from 35 °C to 65 °C	for heat retention function
9.1 / 9.2	Lower part of control valve 3/4", depending on variant for MC/UC	Zone valves for dwelling heating circuits
10	Mixed circuit with (10.1) motorised control valve, type Mut VDE ML and (10.2) backflow preventer (BP) and (10.3) HE pump type GF UPM3 hybrid 15-70 130	(10.2), (10.3) only for MC variants
11	Control valve, type Mut, VDE ML with servomotor	
12	Flow sensor 3/4", type Sika VTY10	1 - 30 l/min
13	Flow controller, depending on variant	(not available with L-Line)
14	Bleeding/drainage plugs 1/2"	heating-system side
18	M10x1 coupler for heat meter immersion sleeve	f. optional. HFM
20	Shut-off ball valve 3/4" (union nut x 3/4" FT)	item-specific equipment
21	(21.1) Domestic water circulation pump with (21.2) BP	item-specific equipment
22	Control and switching module LogoTronic HIU controller	

## Hydraulic diagram

### LogoMatic G2 UC

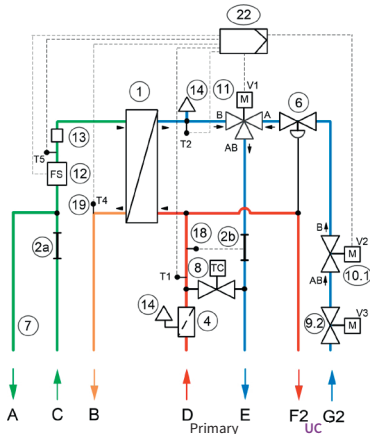

### LogoMatic G2 MC-UC-DHWC (e.g. with optional DWC)

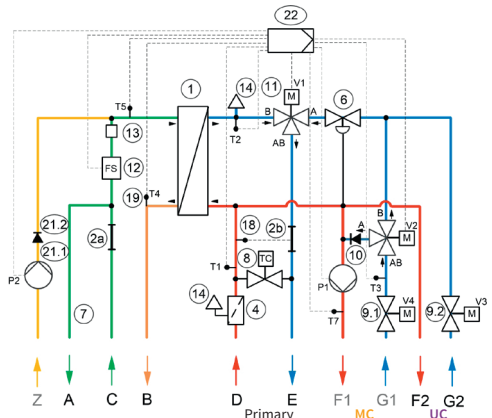

Legend: Connections ¾" MT (without optional ball valves)		UC	MC	MC-UC
A	Cold water outlet for dwelling, (second CW connection)	A	A	A
B	Domestic hot water outlet for dwelling (HW)	B	B	B
C	Cold water inlet building connection (CW)	C	C	C
D	Heating flow line building connection (FL heating)	D	D	D
E	Heating return line building connection (RL heating)	E	E	E
F1/F2	Heating flow line for dwelling heating circuit (FL dwelling), F1-MC / F2-UC	F2	F1	F1/F2
G1/G2	Heating return line for dwelling heating circuit (RL dwelling), G1-MC / G2-UC	G2	G1	G1/G2
Z	Domestic water circulation Z (depending on variant)	-	Z	Z

### Overview of sensors/actors designations

			UC	MC	MC-UC
Temperature sensors (2-wire)					
T1	Flow line	Primary side	T1	T1	T1
T2	Return line		T2	T2	T2
T3	Return line MC		T3	T3	
T4	Domestic hot water	Secondary side PHE outlet	T4	T4	T4
T5	CW (and DWC if available)	Secondary side PHE inlet	T5	T5	T5
T7	Flow line MC		T7	T7	
Valves and pumps (3-/ 4-wire)					
V1	Return line, primary side	DWH/heating	V1	V1	V1
V2	Heating circuit return line	(and mixing valve in case of MC)	V2	V2	V2
V3	Zone valve UC	Servomotor, optional	V3		V3
V4	Zone valve MC	Servomotor, optional		V4	V4
P1	Heating circuit pump MC		P1	P1	P1
P2	DWC pump	with optional DWC	P2	P2	P2

### 3.4 Installation

Please follow the safety instructions in this document and any additional assembly instructions of other components during installation! Installing and operating the stations incorrectly will invalidate any warranty claims.

**Installation options:** depending on variant, either surface- (SM) or flush-mounted (FM) on a wall.

**Note:** for FM variants, optional insulating plates and strips are available separately.

**Dimensions of base plates** (sheets without insulation):

for insulated variant (SM isolated/ SI)

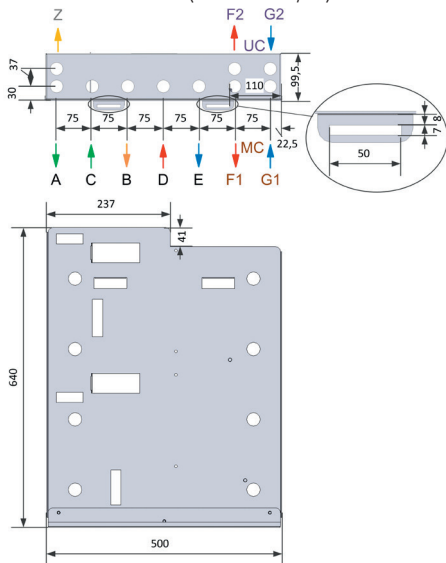

For steel variant (SM/FM)

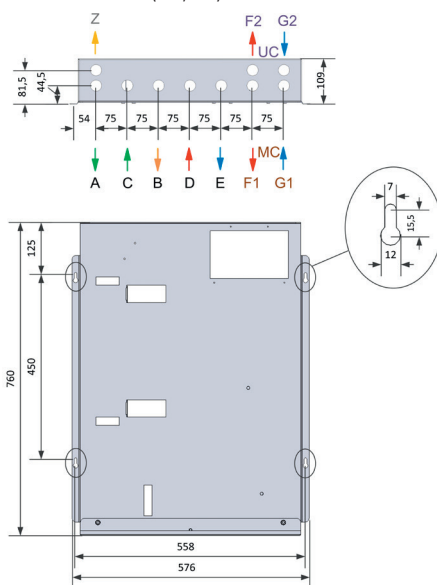

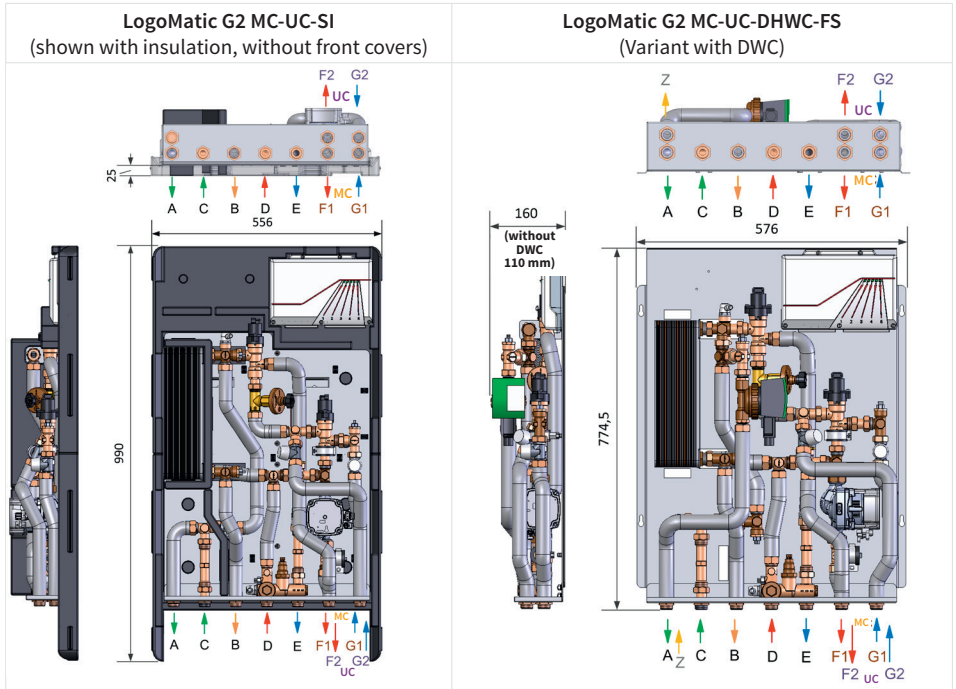
**Unit dimensions and connections:(including example representations)**

**Note:** For the connections legend, see [chap. 3.3](#)

For information on installation depths with different equipment mm and product combinations, see chapter 4.10.6.2.



3.4.1 Insulated surface-mounted variants with multi-part thermal insulation

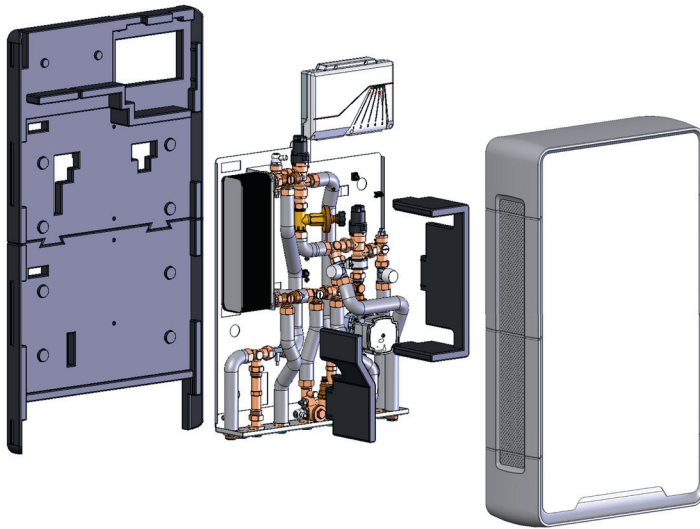

Dimensions of SM thermal insulation and retaining plate (in mm):

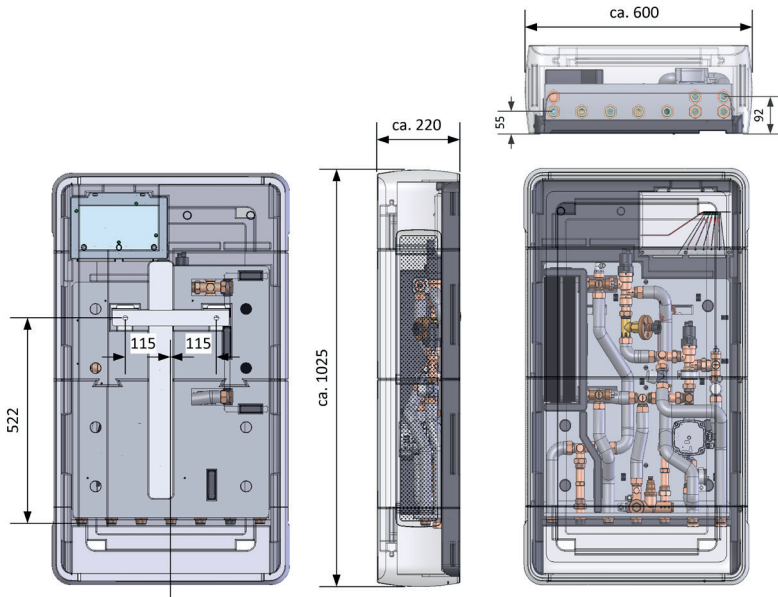

### Construction and installation steps

1. Attach retaining plate to wall (observe the following dimensions)
2. Hang LogoMatic G2 station with rear insulation and stabilisation plate on retaining plate
3. Carry out hydraulic and electrical connections
4. Commissioning (see chap. 5)
5. Attach front insulation parts

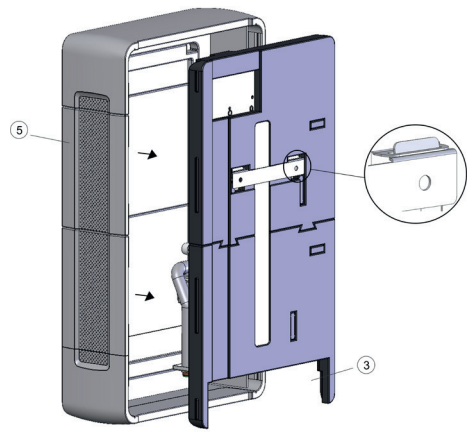
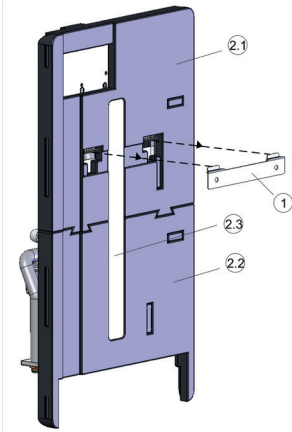

### Legend

Pos.	Description
1	Wall retaining plate
2.1	Rear insulation top
2.2	Rear insulation bottom
2.3	Stabilisation plate
3	Aperture for hydraulic connections
5	Front insulation

### Dimensions of retaining plate (pos. 1) for wall mounting:

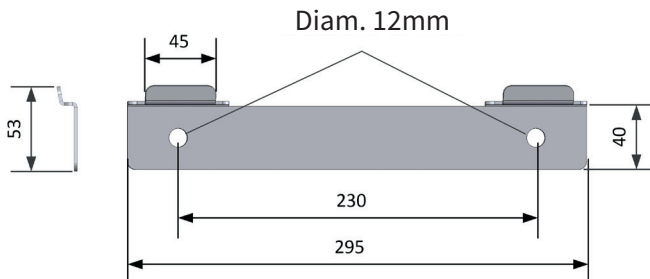

Drill hole dimensions for station installation (for insulated SM variant) and use of optional mounting rail (M10203.762, see also chap. 4.10.5) with throughflow ball valves:

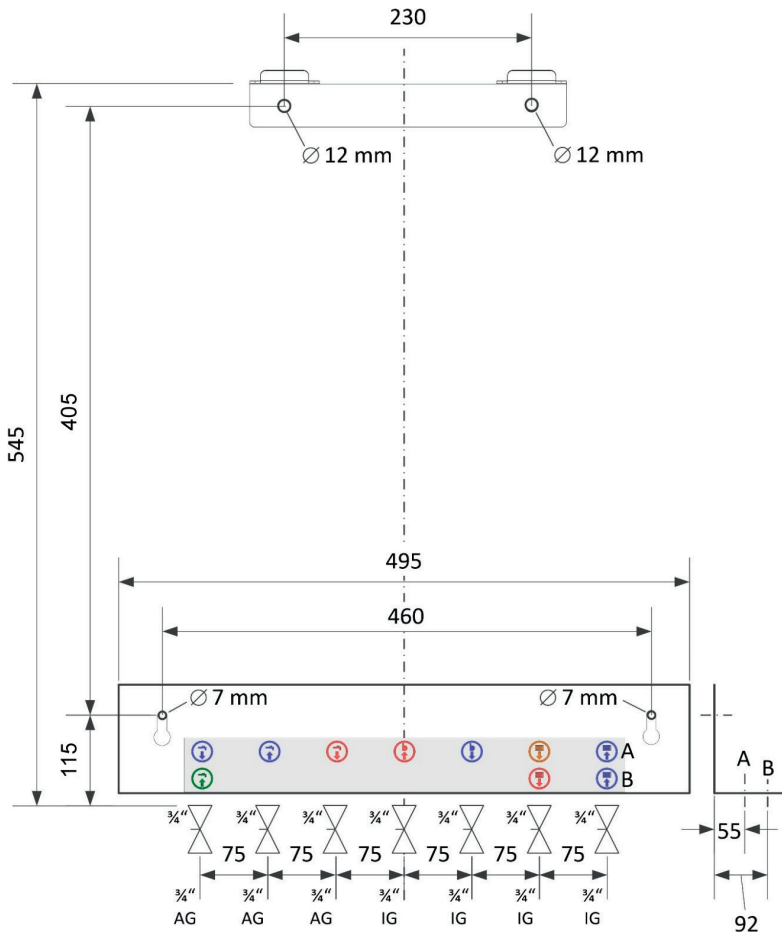

Note: The connections (drinking water, heating) are each labelled with the appropriate symbol.

**Warning!**

Use plastic plugs only to fix the ball valves.

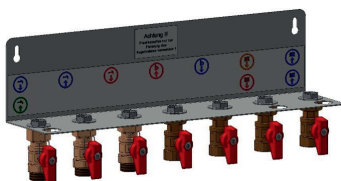

## 4. Individual station components (depending on variant)

### 4.1 Optional heat meter installation

The heat meter may only be installed once the entire heating system has been flushed through. LogoMatic G2 stations are fitted with an adaptor (L = 110 mm, 2 x 3/4") for a heat meter which must be removed before the heat meter is installed.

The corresponding instructions for the HFM must be followed.

#### Procedure:

1. Close all shut-off valves "A" in the station (if present).
2. Lower the system pressure by opening bleeding device "B". **WARNING:** Water may leak from the system.
3. Release the screw fittings on adaptor "C". **WARNING:** Water may leak from the system. (The station can be drained using bleeding device "B" below or the BFD ball valves, where installed.)
4. Remove the adaptor and insert the heat meter and screw in place. **NOTE:** Observe the direction of flow, use seals.
5. Remove the M10x1 plug at "D" and screw in and seal the heat meter supply sensor.
6. Once the work is complete, re-open the shut-off valves and use the bleeding devices to bleed the station. Perform a leak-tightness check.

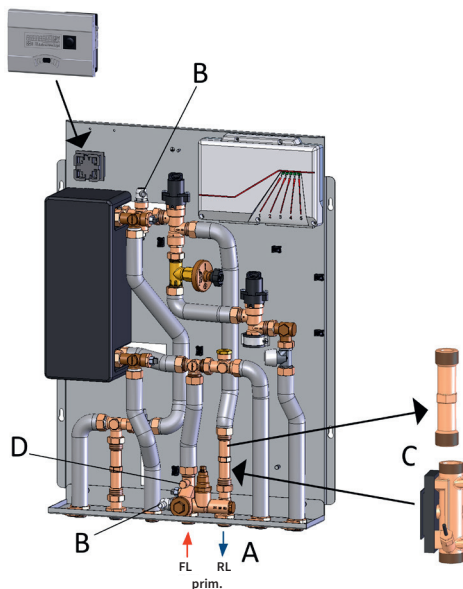

## 4.2 Optional domestic cold water meter installation

LogoMatic G2 stations are fitted with an adaptor (L = 110 mm, 2 x 3/4") for a cold water meter that must be removed before the cold water meter is installed.

The corresponding instructions for the water meter must be followed.

### Procedure:

1. Close all shut-off valves "A" in the station (if present).
2. Release the threaded joints on adaptor "B". WARNING: Water may leak from the system.
3. Remove the adaptor and insert the cold water meter and screw into place. NOTE: Observe the direction of flow, use seals.
4. Once the work is complete, re-open the shut-off valve and check the threaded joints for leaks.

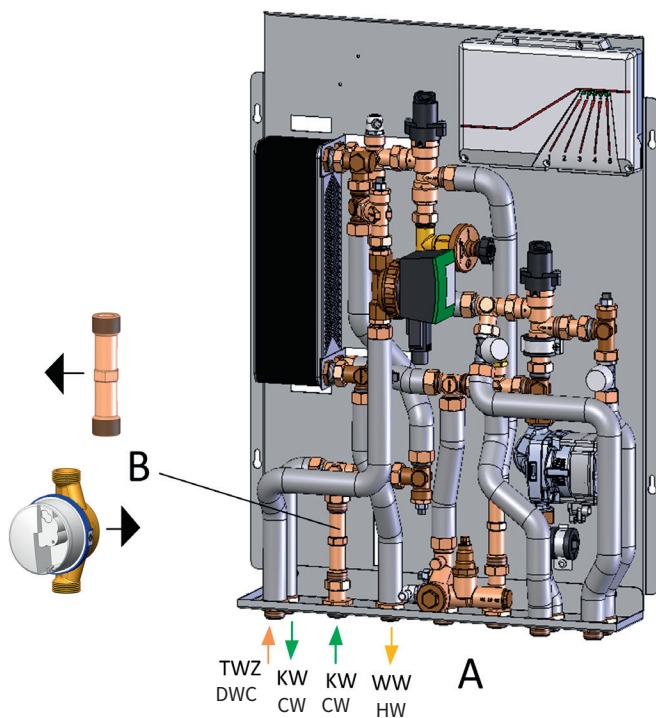

### 4.3 Zone valve for heating circuit

**Setting:**

- Remove the protective cap (white).
- Valve presetting ring with slotted screwdriver: close the valve by doing 2 turns and then set the desired number (1-9). The number 11 means one turn open and then set to 1.
- Take the setting for the desired heating system flow rate from the design documents and adjust it accordingly.

Variants depicted: UC / MC-UC

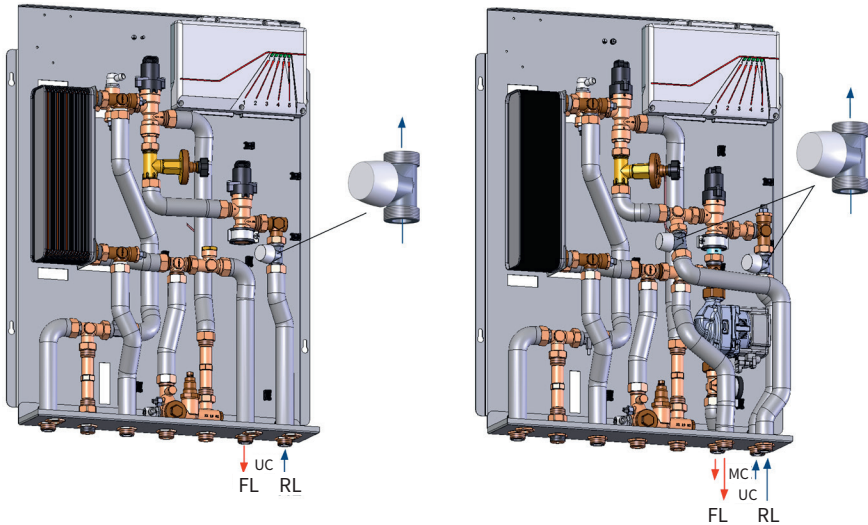

**Reference value diagram (setting curves) for setting the zone valve ( $Kvs = 1.8$ ):**

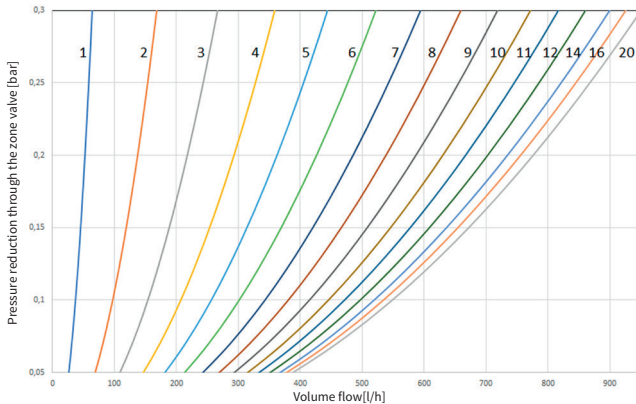

Please notice the separately enclosed installation instructions when for the living space control which is optionally available.

### 4.3.1 Optional safety temperature limitation and actuator

STL safety temperature limitation (as contact thermostat) and 230 V electrothermal actuator (NC) as optional accessories:

The safety temperature limiter (STL) interrupts the power supply to the pump if the set temperature is exceeded and switches it back on if it drops below the set temperature.	Technical data – STL	
	Adjustment range:	20–90 °C
	Switched power:	16 (2.5) A, 250 V
	Temp. gradient	≤ 1 K/min
	Protection code:	IP 20
	Dimensions:	112 x 46 x 55 mm
Cable grommet	M20 x 1.5	

#### Installation steps:

1. Use the tightening strap to fasten the contact thermostat to the MC FL pipe to ensure a good contact for heat transfer. (to do this, remove the insulation from the tube.)
2. After loosening the bolts, remove the cover.
3. Connect to the electricity supply in accordance with the following circuit diagram.
4. Fix the cable to the strain relief clamp.
5. Fit the cover and fasten with the bolts.

The electrical connection plan must be observed!

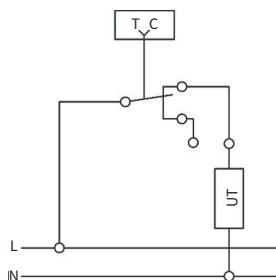

#### 4.4 Dirt trap and thermostatic circulation bridge

Design

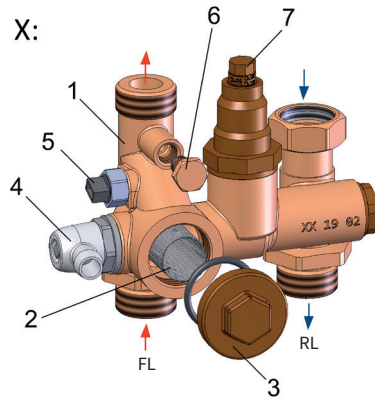
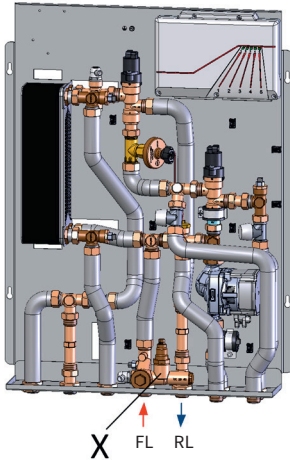

X - Multifunction assembly with dirt trap and therm. circulation bridge

#### Legend

No.	Components	Comment
1	Multifunctional assembly	G $\frac{3}{4}$ "
2	Sieve insert for dirt trap	D = 20 x 40 mm, mesh size 0.5 mm
3	plugs	M30 x 1.5
4	Drainage/emptying plugs	G $\frac{1}{2}$ "
5	Screw-in temperature sensor	G $\frac{1}{8}$ "
6	Plug for optional HFM temp. sensor	M10x1
7	Thermal Circulation bridge with setting spindle	Adjustment range: 35 – 65 °C

**The dirt trap** in the station's heating water inlet protects the system against sludge and impurities. These can be flushed through by opening the locking plug (3) The station must be depressurised beforehand.

**The thermostatic circulation bridge** guarantees lag-free provision of the heating medium for water heating. The supply temperature can be continuously adjusted between 35 °C and 65 °C on the temperature scale. Adjust the value by screwing the spindle in or out with an open-ended spanner (11 mm).

Factory setting: closed (fully turned in, right stop)

**Note:** When using an optional HFM, the volume flow transferred via the therm. circulation bridge is not taken into account.



## 4.5 Differential pressure regulator

The differential pressure regulator is used for the hydraulic balancing of the heating circuits.

Variants depicted: UC / MC-UC

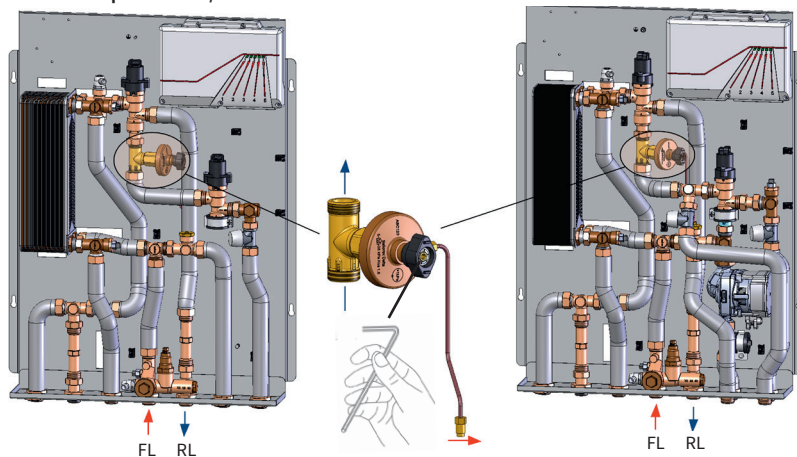

### Setting with 4-mm hexagon socket wrench



To adjust the differential pressure regulator, rotate the hexagon socket wrench anticlockwise until the end point is reached and the spring is fully released. At this point, turn the hexagon socket wrench in clockwise until it reaches the setting value (desired differential pressure) described in the table below.

The black handle is used to block the flow.

For the specifications for setting the differential pressure regulator, please refer to the design documents.

### DP regulator valve: DN15 AG/AG

Flow range:	18-800 l/h
Adjustment range:	5-25 kPa
Factory setting:	10 kPa

### Valve settings for desired differential pressure

Rotations	0	1	2	3	4	5	6	7	8	9	10	11	12	13	14	15	16	17	18	19	20
Dp [kPa]	5	6	7	8	9	10	11	12	13	14	15	16	17	18	19	20	21	22	23	24	25

**Note:** The line must be filled so that the pressure in the flow line is not considerably higher than that of the return line, otherwise the DP regulator valve will close.

## 4.6 Control valves

Both control valves (X) and (Y) control the priority switching for domestic water heating (DWH) or the secondary heating circuit supply. For the DWH, control valve (Y) is completely closed, and control valve (X) ensures the desired DHW temperature based on the prim. RL flow

Variants depicted: UC / MC-UC

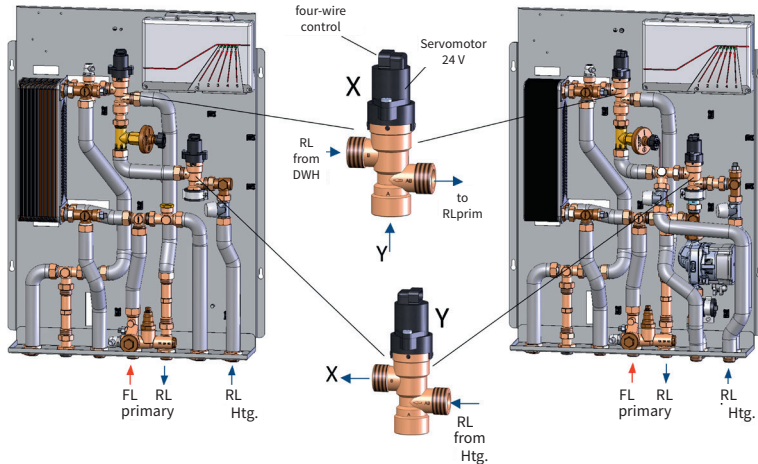

**Please note:** the flow through valve (X) is opposite the direction of the arrow (with AB). A and B are used as inputs.

The electrical control of the mounted actuators (24 V stepper motors) is carried out via the station controller (LogoTronic HIU controller), which receives corresponding signals from the flow or temperature sensors.

### Warning!

The stepper motors may not be removed from the associated valve bodies because, with this kind of valve, the motor shaft is permanently connected to the internal valve ball and removing the motor would render the entire valve unserviceable as well as allowing heating water to leak out at these points.

The manufacturer-specific documents for the valve must also be observed!

### 4.7 Mixed heating circuit (depending on variant)

Note: Function available only for LogoMatic G2 MC variants

- Mixing circuit as injection system
- MC variant with (P1) HE pump and (V4) zone valve for e.g. underfloor heating circuits

Configuration:

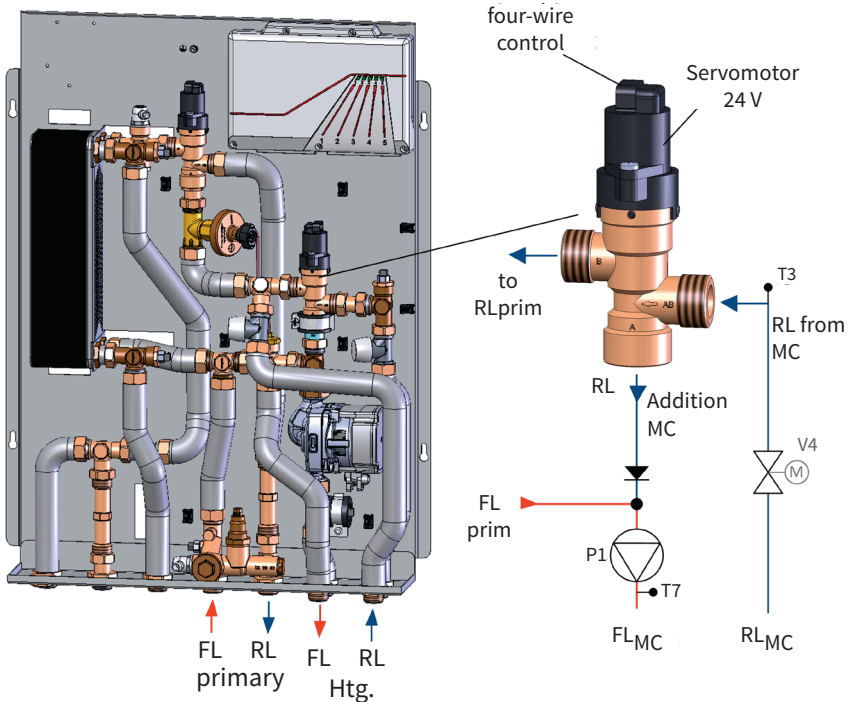

#### 4.7.1 High-efficiency heating circuit pump

The additional enclosed documents concerning the pump must be observed. Depending on the system, the pump must be adjusted/adapted to the requirements on site.

The GF UPM3 Hybrid 15-70 130 pump is controlled externally by a PWM signal.



##### Electrical data:

Power supply: 230 V, 50 Hz

##### Technical data:

Revolution speed	P1 (W)	I1/I [A]
MIN.	2	0.04
MAX.	53	0.52

Operating pressure	max. 1.0 MPa
Minimum supply pressure:	0.05 MPa
Media temperature:	+2 to +110 °C

The LEDs (one red/green and 4 yellow) indicate the corresponding operating/alarm status.

Please observe the respective information provided by the pump manufacturer.

##### Performance characteristics:

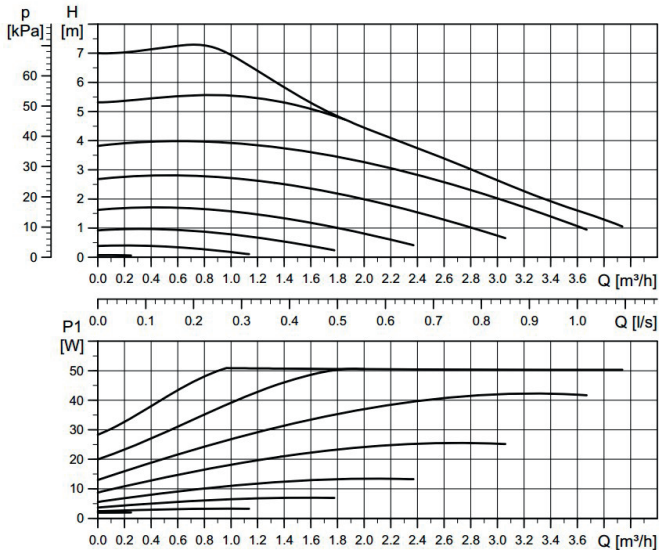

### De-blocking Grundfos pump, type UPM3:

Should the pump be blocked after a period of disuse and fail to start, the status indicator LED 1 = red and LED 5 = yellow will be displayed. The pump will make repeated autonomous attempts to start electronically with maximum torque for a few seconds.

If the problem persists, the following manual steps can also be taken:

In this case, please use the appropriate Phillips screwdriver, e.B. Phillips No.2, and insert it into the front opening in the middle of the pump (see figures). Then press and rotate the piston briefly in both directions with the aid of the screwdriver.



The LogoTronic HIU controller must be permanently connected to the power supply when the system is filled to counteract interference!

## 4.8 Hot water throttle

LogoMatic G2 stations (only S- and M-Lines) are fitted with a hot water throttle in the connecting pieces of the plate heat exchanger. The model with gasket simplifies the exchange process.

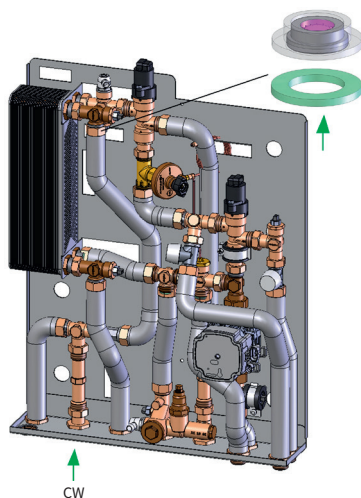

The following throttle plates can be used as required, e.g.:

S-Line Colour code – red

M-Line Colour code – purple

(L-Line: without hot water throttle)

## 4.9 Domestic water circulation with pump and BP

The domestic water circulation system is used to provide a constant supply of hot water to the taps. Long periods of disuse should be avoided! Please ensure that you comply with the relevant technical regulations and guidelines.

**Note:**

The domestic water circulation is set to the "Cycle" operating mode in the factory. The domestic water circulation may only be put into operation once the station has been filled with domestic water (voltage supply 230 V). Otherwise the circulation function or connector must be taken out of operation in order to prevent the risk of it running dry.

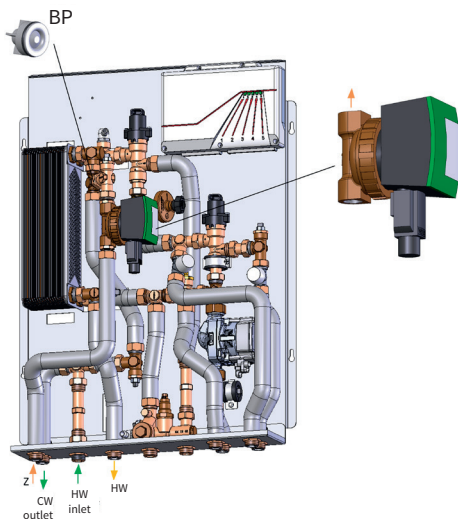

A DN15 plug-in backflow preventer (RV) is installed on the pressurised side of the circulation pump on the domestic water side in order to prevent unwanted circulation.

The domestic water circulation pump (Wilo-Star Z Nova) is suitable for use in hard water grades of up to 20°dH.

Please refer to the electrical wiring diagram for the electrical installation.

The LogoTronic HIU controller must be permanently connected to the power supply when the system is filled to counteract interference!

**Note:**

The safety fuse of the sanitary installation in a dwelling with a domestic water circulation connection must comply with DIN 1988, i.e. with a safety valve and, if necessary, an expansion vessel.

Pump characteristic curve of optional DWC pump:

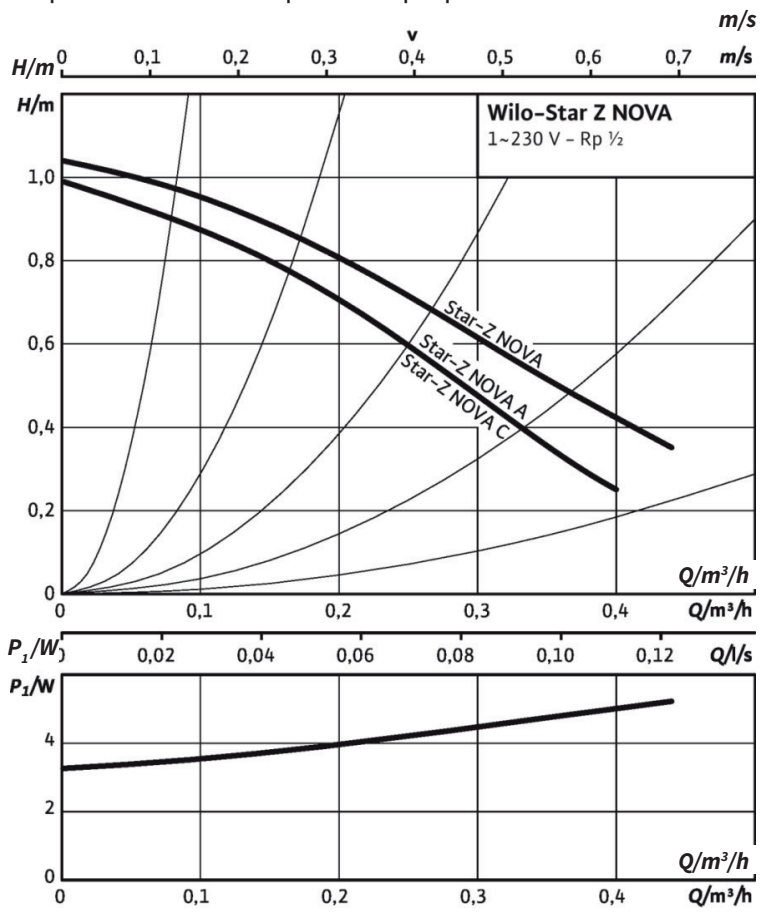

## 4.10 Optional accessories

e.g. heating circuit manifold for insulated SM variant and ball valves

Example representation:

LogoMatic G2 MC-UC-SI with ball valves and 8x heating circuit manifold

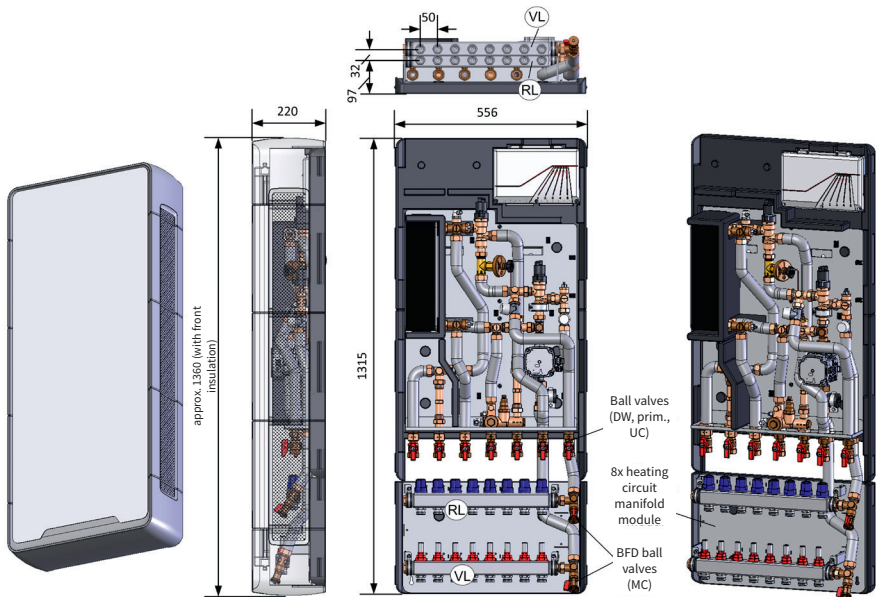

**Further optional accessories, such as:**

FM hoods, thermal insulation, ball valves, mounting rails, HC manifolds, terminal strips, etc.: see relevant price list, web page and related data sheets



#### 4.10.1 Heating circuit manifolds

<b>Manifold variants</b>	Standard: 3 - 8 heating circuits (SI/FS), wide version 9-12 HC
<b>Features</b>	Emptying, bleed valve in the flow and return line, max. 6 bar Flow rate limiter 0.5 - 5 l/min M30x1.5 valve inserts with manual adjustment caps Stainless steel manifold mounted on base plate
<b>Connections</b>	G 3/4" above to the apartment station, 3/4" MT Eurocone to the heating circuits

#### Example representation (8x heating circuit manifolds):

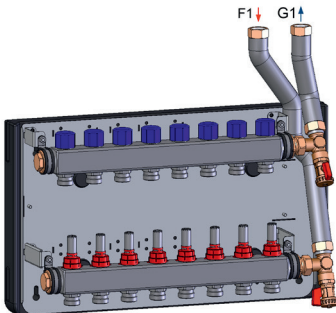
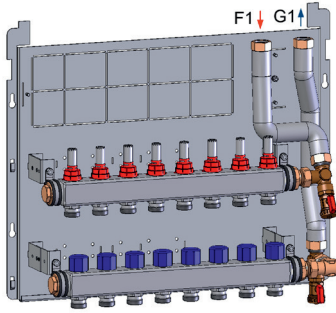
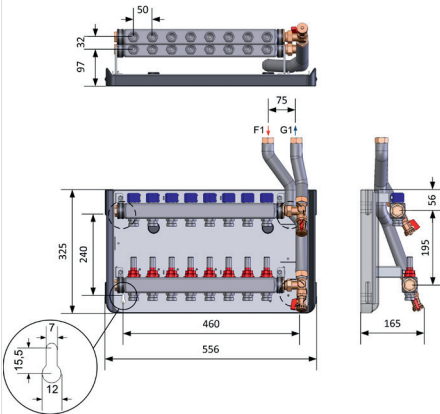
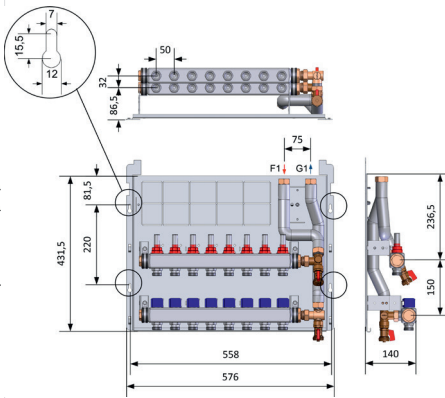
with insulated SM variants:	for SM/FM sheet metal housing variants:
	
	
<p><b>Art. no.:</b></p> <ul style="list-style-type: none"> <li>3x: M10515.32</li> <li>4x: M10515.42</li> <li>5x: M10515.52</li> <li>6x: M10515.62</li> <li>7x: M10515.72</li> <li>8x: M10515.82</li> </ul>	<p><b>Art. no.:</b></p> <ul style="list-style-type: none"> <li>3x: M10515.31</li> <li>4x: M10515.41</li> <li>5x: M10515.51</li> <li>6x: M10515.61</li> <li>7x: M10515.71</li> <li>8x: M10515.81</li> </ul>

### Underfloor manifold (wide version) 9 - 12x heating circuits:

Width x height x depth [mm] 792 x 430 x 140\* (dimensions of the housings to be taken into account)

Example representation:

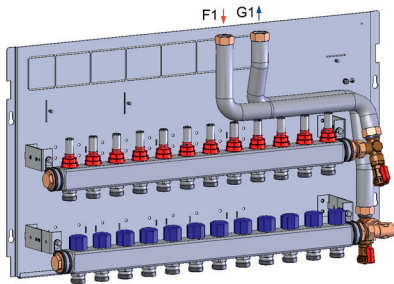

**Art. no. for wide underfloor heating manifold:**

9x: M10512.91  
 10x: M10512.101  
 11x: M10512.111  
 12x: M10512.121

\*installation depth increases to 160mm if prewiring packages are used or increases in general if floor terminal blocks and their mounts are installed.

#### 4.10.2 Terminal strip for underfloor heating circuit manifolds

Information on prewired UFH terminal strip (IP44, supply voltage of actuator 230 V):

- for use with 8 to 12 zones (up to 18 actuators, so that multiple actuators per zone can be connected)
- with pump logic module
- incl. safety temperature limiter (STL) with thermal actuator
- folding retaining plate for terminal strip



#### Art. no. for UFH terminal strips:

SM/FM variants with sheet steel housing (FS)	with prewiring concept up to 8 HC / zones	MB-10560.06
	with prewiring concept up to 12 HC / zones	MB-10560.07
SM insulated variants (SI)	with prewiring concept up to 8 HC / zones	MB-10560.08

#### Warning:

The actuators needed in each case corresponding to the number of underfloor heating circuits must be ordered separately!

### 4.10.3 Static heating circuit (with MC-UC variants) and simultaneous heating circuit distribution

Sample depiction of extension of the static heating circuit (UC-L) with 3/4" MT connection

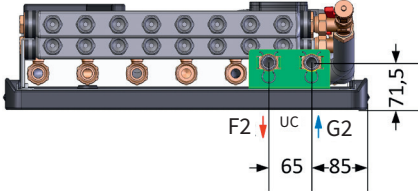
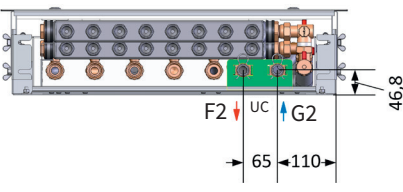
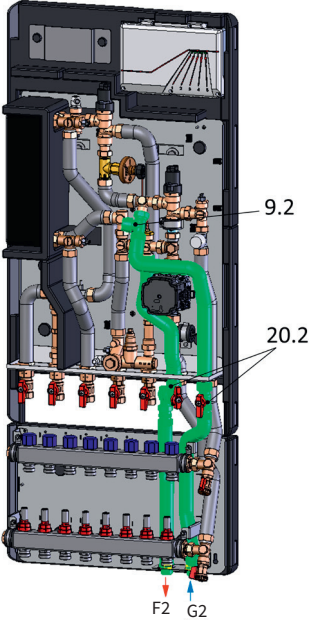
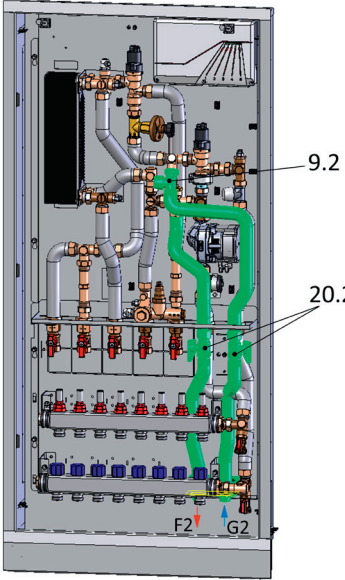
with LogoMatic G2 MC-UC-SI variants (surface-mounted version as insulated housing)	with LogoMatic G2 MC-UC-FS variants (surface-/flush-mounted version as sheet steel housing)
	
	
<p>Lower extension: Art. no.: M10253.21</p>	<p>Lower extension: Art. no.: (up to 8 HC MC) M10253.19 (for wider version up to 12 HC) M10253.20</p>

#### Legend:

- (9.2) Zone valve for static heating circuit (UC)
- (20.2) Shut-off ball valves in both UC flow/return line (F2/G2)

#### 4.10.4 Ball valve sets, DN 20 straight (BV)

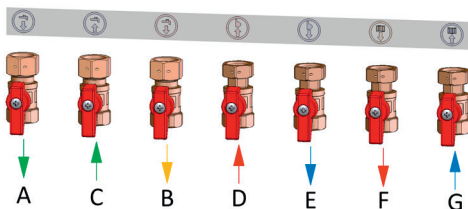



Legend see chapter 3.3

Ball valves with 3/4" FT x 3/4" FT union nut, domestic water ball valves DVGW tested	Art. no.
7x ball valves (3x for domestic water connection) and 3/4 gaskets	M10252.391
5x ball valves (3x for domestic water connection) and 3/4 gaskets for e.g. variants with heating circuit manifolds	M10252.39

Note: Please follow the separate instructions for the ball valve sets.

#### 4.10.5 Mounting rails with ball valves (FFR)

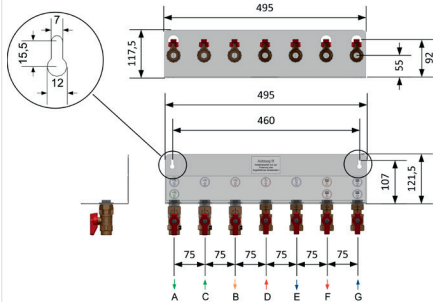
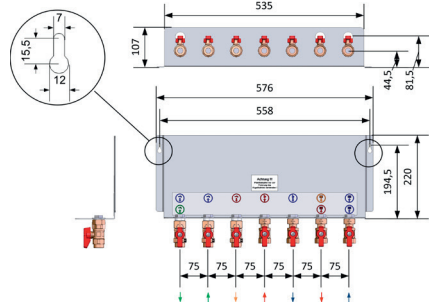
There are two different variants:

for SI (SM) stations (surface-mounted version as insulated housing)	for FS (SM/FM) stations (surface-/flush-mounted version as sheet steel housing)
	
	
Art. No.: M10203.762	Art. No.: M10203.749
in each case incl. 7x 3/4" straight-way ball valves, seals, plugs and the circuit diagram	

Note: Please use plastic plugs only to fix the ball valves.

## 4.10.6 Cover hoods and cladding housing

### 4.10.6.1 Overview of SM hoods (S or SM)

Example representations

Fig. SM, dimensions in [mm]	Height A	Width B	Depth C	Notes
	900	600	210	Standard surface-mounted hood, coated steel, white (RAL 9016) Art. no.: M11100.11  Note: For wireless use, select plastic variant (-K). Art. no.: M11100.11K
	1330	600	210	for variants with UFH: Long hood for underfloor manifolds with max. 8 circuits. coated steel in white (RAL 9016) Art. no.: M11100.46 /-K
	1330	850	210	Design for wide UFH manifolds (for more than 8 heating circuits): Art. no.: M11100.43  Plastic design: Art. no.: M11100.43K
<b>For insulated SM variants (SI):</b> -as designer insulation housing -with white fascia panel -and 30 mm wall thickness	1050	600	220	Standard variant: Art. no.: M66306.665
	1375	600	220	Long variant for UFH: Art. no.: M66306.666

### 4.10.6.2 Depth specifications for flush-mounted hoods (F or FM)

depending on station configuration:

FM (F) variants	minimum possible installation depth in [mm]
Standard / with insulation	110 / 150
Standard with DWC / and with insulation	160 / 200
with UFH manifold / and with insulation	140 / 160
with UFH manifold, with DWC / and with insulation	160 / 200
with UFH manifold* / and with insulation*	160 / 180
with UFH manifold, with DWC* / and with insulation*	160 / 200

\* with prewiring concept

#### 4.10.6.3 Overview of flush-mounted hoods (F or FM)

Example representation

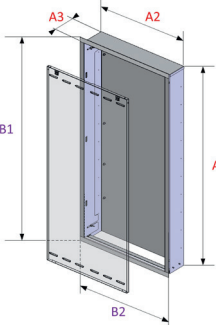
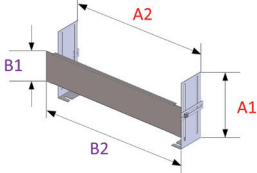
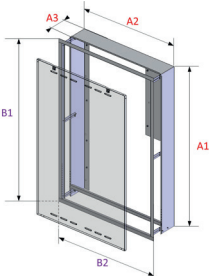
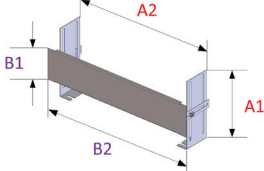
Fig. FM, dimensions in [mm]	Installation dimensions A			Installation dimensions B	
FM cover, completely enclosed, coated steel in white (RAL 9016)	Height A1	Width A2	Depth A3 (from-to)	Panel height B1	Panel width B2
	930	610	110-160	953	655
	for variants with underfloor heating connection (manifold with max. 8 circuits):			Art. no.: M11100.38 Plastic design: M11100.38K	
	1300	610	130-210	1327	655
	220	610	Height adjustable from: 100 to 170 mm	100	655
				Art. no.: M11100.21  Note: for hoods M11100.38 /-38K Art. no.: M11100.35	
	1295	826	Depth: (150 or) 165 to 245 mm	1322	871
				Art. no.: M11100.42 (Design for wide UFH manifolds)  Plastic design: Art. no.: M11100.29K	
	220	826	Height adjustable from: 100 to 170 mm	100	871
				Art. no.: M11100.71	

**Note:**

One additional factory-supplied thermal insulation pack per FM hood is available, art. no.: M66306.667

#### 4.10.7 Sample configurations (or complete stations CS)

Overview of complete stations (CS) LM G2, M-Line:

Model	Heating type	copper-soldered PHE (CU)	sealed copper-soldered PHE (SX)
SI insulated SM version	UC	M11114.1HKAP (see example I)	M11114.1HKAPSX
	6MC	M11114.61MKAP	M11114.61MKAPSX
	8MC-UC	M11114.81MKAP	M11114.81MKAPSX (see example II)
SM/FM or SF with sheet steel housing	UC	M11114.1HKUP	M11114.1HKUPSX
	6MC	M11114.61MKUP	M11114.61MKUPSX
	8MC-UC	M11114.81MKUP	M11114.81MKUPSX (see example III)

#### I) LogoMatic G2 UC-SI, M-Line, with ball valves

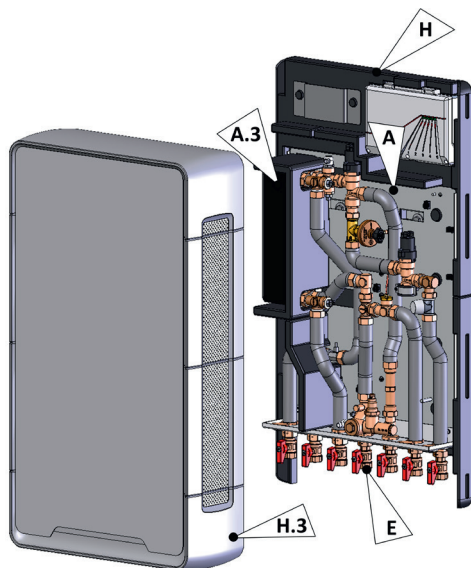

component list (I) or as complete station CS: M11114.1HKAP

Pos.	Designation	Art. no. (example)
A	LM G2 prefabricated station as SI (SM), M-Line, UC, without DWC	M11114.44
A.3	copper-soldered PHE (CU)	
E	7x ball valves, DN20, straight	M10252.391
H	SM Insulation SI, rear	included with pos. H.3
H.3	Designer insulated housing SI (standard version) with fascia panel	M66306.665

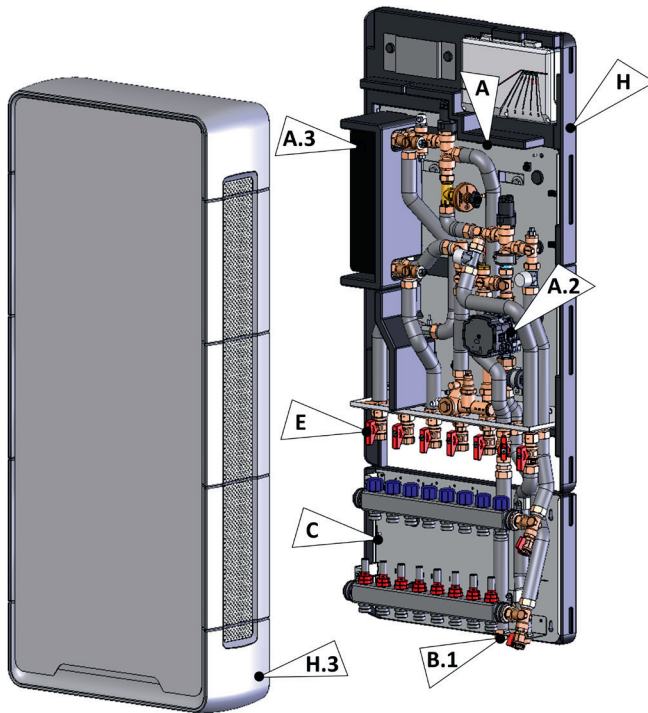
**II) LogoMatic G2 MC-UC-SI, M-Line with 8x UFH manifold, connection group for stat. HC**

**Component list (II) or as complete station CS: M11114.81MKAPSX**

Pos.	Designation	Art. no. (example)
A	LM G2 prefabricated station as SI (SM), M-Line, MC-UC, without DWC	
A.2	HE pump for MC circuit	M11114.642
A.3	Sealed copper-soldered PHE (SX)	
B.1	Extension for connection of stat. HC SI (UC)	M10253.21
C	8x underfloor heating manifolds for SI variant	M10515.82
E	5x ball valves, DN20, Straight	M10252.39
H	SM Insulation SI, rear	included with pos. H.3
H.3	Designer insulated housing SI (long version) with fascia panel	M66306.666

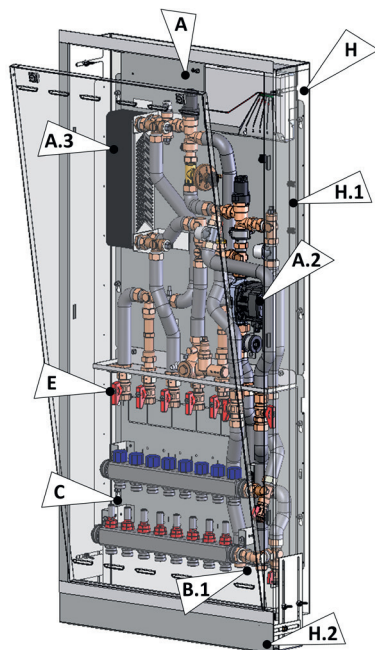

III) LogoMatic G2 MC-UC-SF, M-Line with 8x UFH manifold, connection group for stat. HC



Component list (III) or as complete station CS: M11114.81MKUPSX

Pos.	Designation	Art. no. (example)
A	LM G2 prefabricated station as SF (SM/FM), M-Line, MC-UC, without DWC	M11114.612
A.2	HE pump for MC circuit	
A.3	Sealed copper-soldered PHE (SX)	
B.1	Extension for connection of stat. HC (UC)	M10253.19
C	8x underfloor heating manifolds for sheet steel housing variant	M10515.81
E	5x ball valves, DN20, Straight	M10252.39
H	FM hood, long version, e.g. as plastic model*	M11100.39K
H.1	factory-provided thermal insulation pack*	M66306.667
H.2	Height-adjustable feet with cover trim	M11100.21

\* in other version or not included in this station

## 5. Commissioning

Before using our products, they must be checked for suitability for the respective planned application. Please bear in mind the water quality at the installation location, particularly for domestic water applications. In the case of critical domestic water qualities, please take suitable measures where necessary (e.g. water treatment) in order to prevent functional impairment and/or damage, e.g. corrosion damage.

In particular, please check the permissible limit values, e.g. for electrical conductivity, the pH value, the German hardness level and the ammonium concentration. You will find further information under the "Docfinder" tab at [www.flamcogroup.com](http://www.flamcogroup.com) "Information on water quality, preventing limescale deposits, stone formation and corrosion in systems with decentralised hot water preparation".

The LogoTronic HIU controller must be connected to the power supply at all times, especially for the pumps and actuators.

Use the associated app for commissioning.

### 5.1 Flushing and filling

#### **Note for the installer:**

Heating systems must be flushed through prior to commissioning in accordance with the local regulations, such as DIN EN 14336, VOB ATV C DIN 18380 or VDI 2035. After the system has been filled for the first time, the recirculation pump must be left to run for about 1 hour before it can be switched off for a longer period.

#### **Flush the system carefully before filling.**

Check all connections and tighten them if necessary.

Ensure all threaded joints are locked tight.

Once the system has been filled, bleed the station and refill the heating system as required.

### 5.2 Initial start-up

Commission the station once it has been flushed and filled and a pressure test has been carried out. All heating and sanitary installation work must be complete. Bleed the station every so often during the commissioning process (for bleeding options: cf. chapter 4.1).

Please observe the instructions, benchmarks and settings for the control fittings specified in our service log when commissioning. The LogoTronic HIU controller must be connected to the power supply at all times when the system is full, especially for the pumps and actuators.

The following requirements must be met for successful commissioning:

- All components of the system are installed and assembled.
- The entire system is leak-tight.
- All necessary electrical connections have been made.
- A terminal device (tablet / smartphone) is available with the Flamconnect app installed.



This free app is required for further settings/configurations on the controller. It can be downloaded via the web page [www.flamcogroup.com](http://www.flamcogroup.com) or the QR code shown here.

Please note the additional documentation for the app and the LogoTronic HIU controller.

<https://flamcogroup.com/flamconnect-app-download>

## 6. Maintenance and service

Maintenance and service work must be performed and documented by a trained expert.

Information regarding domestic water hardness: The propensity for natural water to form limescale deposits depends, among other things, on various factors such as the concentration of calcium and magnesium salts, the pH value and the temperature.

If what is known as the lime-carbonic acid balance has been disturbed by an increase in the pH value and/or the temperature, the calcium carbonate precipitates in the form of calcite crystals.

The applicable standards and corresponding technical regulations (e.g. DIN and DVGW) must therefore be observed.

### Note:

Request a water analysis from the local utility companies for testing in the event of known regional risks or contested water quality.

### Propensity for scaling guidelines as per VDI 2035

Hardness range	Millimoles of calcium carbonate/litre	Degree of hardness in °dH	Domestic water temperature		
			< 60 °C	60-70 °C	> 70 °C
Soft	< 1.5	< 8.4	low	low	low
Medium	1.5 – 2.5	8.4-14	low	low	medium
Hard	> 2.5	> 14	low	medium	high

## 7. Pressure loss characteristic curves

Note: Please refer to our current LogoMatic G2 product brochure for performance diagrams.

Pressure loss on the secondary side of the device (hot water section) in dependence on drawn off domestic water volume

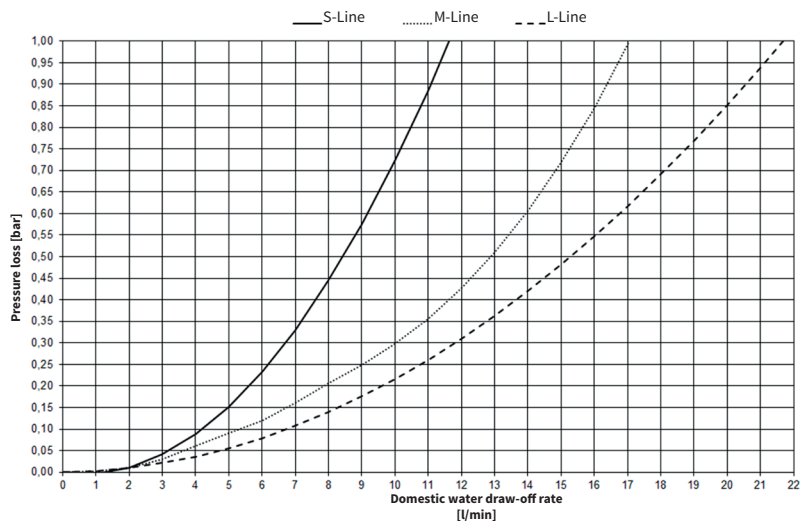

Pressure loss on the secondary side of the device (cold water section) in dependence on drawn off domestic water volume

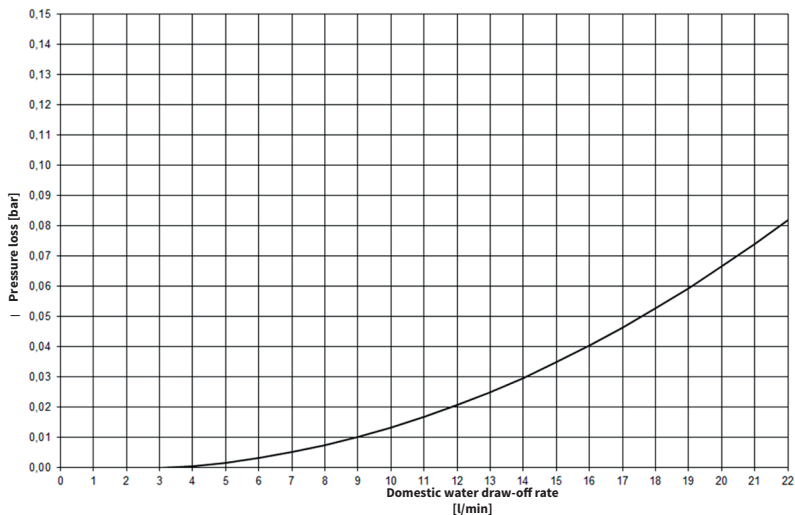

Pressure loss on the primary side of the device in dependence on hot water flow rate \*

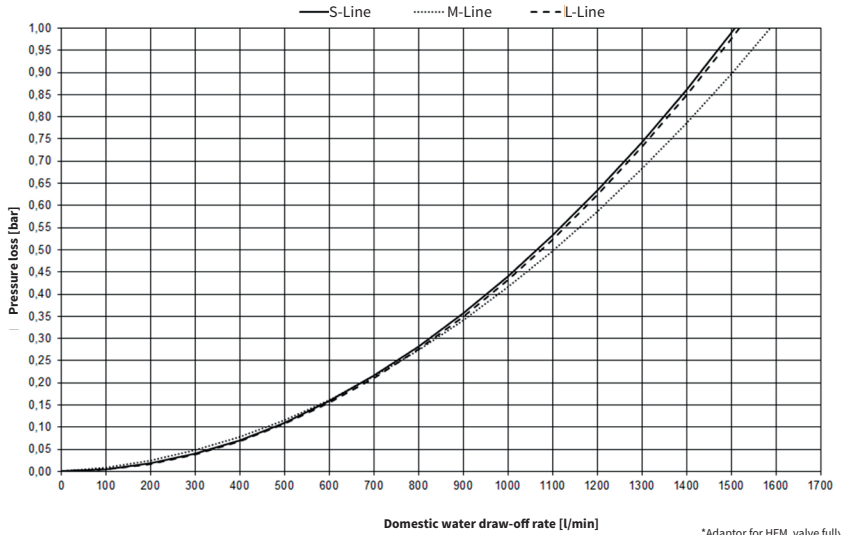

\*Adaptor for HFM, valve fully open

Pressure loss on the heating side of the device in dependence on hot water flow rate \*

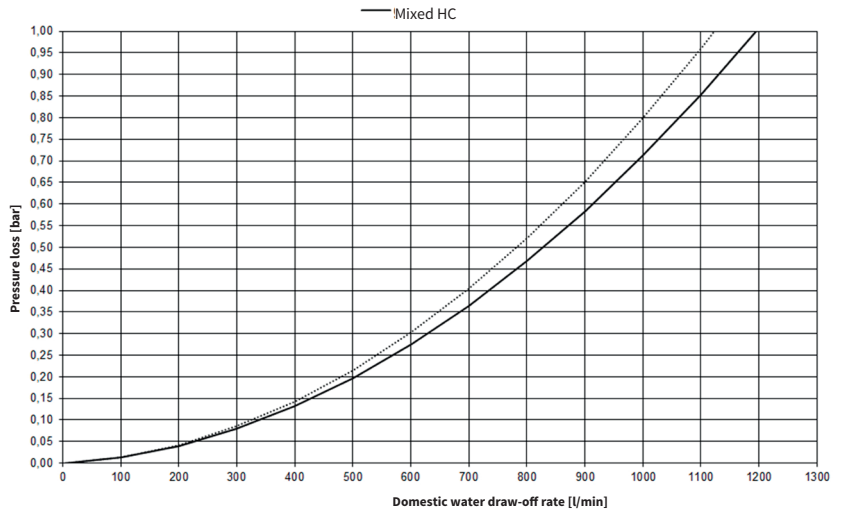





\*Adaptor for heat flow meter, pump and differential pressure regulator, valve and zone valve

## 8. Troubleshooting

The following overview is intended to help with the location of the causes of faults.

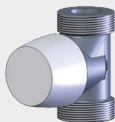
1. Check status display on LogoTronic HIU controller
2. Check shut-offs
3. Check power supply
4. Check system for air
5. Check flow volume (DW and heating), media pressure and temperatures
6. Check dirt trap at device inlet and domestic water flow sensor
7. Check cold water throttle/flow limiter for domestic water
8. Check target settings in the LogoTronic HIU controller and at the components
9. Check functionality of all components
10. Check performance of components against required performance
11. Check functionality of backflow preventer
12. Check switched heat demand

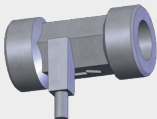
## 9. Spare parts

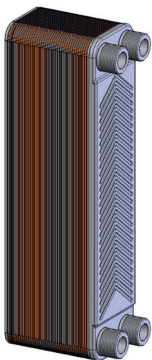
Components	Fig.	Art. no.
Zone valve*		ME-80576.01
Mut valve*		ME-80590.82
Volumetric flow meter*		ME-69001.13
Sensor package	Screw-in temp. sensor G1/8" and red. nipple 1/2" MT and 1/8" FT	ME-10576.121
LogoTronic HIU controller Controller without wiring harness		ME-10576.72
E8x24*		ME-10230.5
E8x24 Sealix*		ME-10230.515
E8ASx40*		ME-10230.612
E8ASx42 Sealix*		ME-10230.613
E8LASx60*		ME-10232.71
E8LASx60 Sealix*		ME-10232.74

Components	Fig.	Art. no.
Seal package	Centellen seals: 2x1", 5x 3/4"	ME-43.6615
Circulation pump*		ME-45101.1710
Heating circuit pump*		ME-45101.76
STM		M45160.01
DPCV		M80597.550

\*in each case, replace seals





**Meibes System-Technik GmbH**

Ringstraße 18

D-04827 Gerichshain

Deutschland

+49 342 927 130

info@meibes.com

[www.flamcogroup.com](http://www.flamcogroup.com)

Man\_LogoMatic\_G2\_eng\_24002.940\_2020/12

Copyright Flamco B.V., Almere, the Netherlands. No part of this publication may be reproduced or published in any way without explicit permission and mention of the source. The data listed are solely applicable to Flamco products. Flamco B.V. shall accept no liability whatsoever for incorrect use, application or interpretation of the technical information. Flamco B.V. reserves the right to make technical alterations.